

**Tools required**

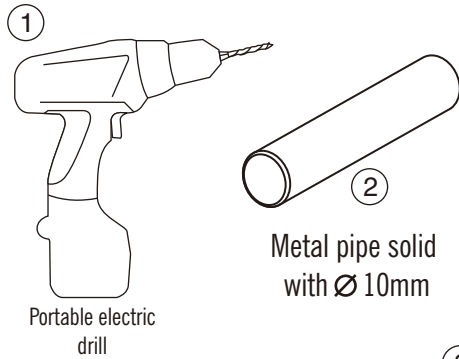

Metal pipe solid with  $\varnothing$  10mm

Portable electric drill

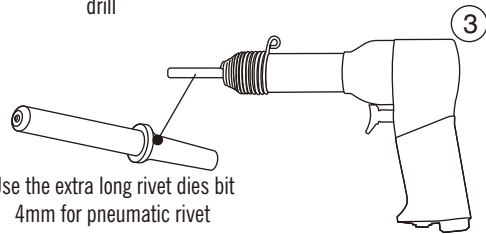

Pneumatic Rivet set with Bucking Bars

Use the extra long rivet dies bit 4mm for pneumatic rivet

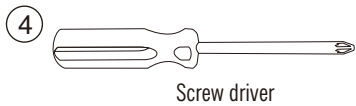

Screw driver

1 Set right casing, rivet and washer

1 Set left casing, rivet and washer

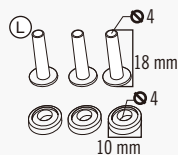
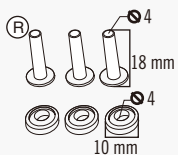
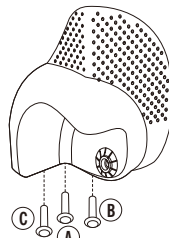
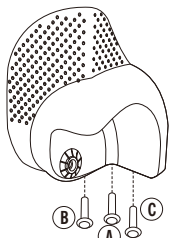

<p>Drill the rivet (A) (B) (C) using tool (1) Remove the screw (B) (C) turning anticlockwise using tool (4)</p>	<p>Put the rivet (A) (B) (C) through from inside the bag. Put the washer (A) (B) (C) inside the bag. Put back the screw (B) (C) turning clockwise using tool (4)</p>	<p>- Hold the outside (A) (B) (C) rivet using tool (2). - Inside rivets (A) (B) (C) punched using tool (3) until secure and tighten with (A) (B) (C) washer.</p>

RIGHT WHEEL CASING ASSEMBLY INSTRUCTION

<p>Drill the rivet (A) (B) (C) using tool (1) Remove the screw (B) (C) turning anticlockwise using tool (4)</p>	<p>Put the rivet (A) (B) (C) through from inside the bag. Put the washer (A) (B) (C) inside the bag. Put back the screw (B) (C) turning clockwise using tool (4)</p>	<p>- Hold the outside (A) (B) (C) rivet using tool (2). - Inside rivets (A) (B) (C) punched using tool (3) until secure and tighten with (A) (B) (C) washer</p>

LEFT WHEEL CASING ASSEMBLY INSTRUCTION